

Instruction Manual

MG-05

(UV Radiometer)



1. Product Features and Applications
2. Product Specification and Configuration
3. Product Installation
4. Operation
5. Relative Reaction Curve of UV Sensor
6. A/S Request in Case of Product Failure
7. Notes
8. Relay Operation method

1. Product Features and Application

1) Features

Display is 3 types : Relative Power (RP), Accumulative Time (AT) and Absolute Power (AP)

Output is 3 types : DC Voltage, DC Current and Relay

2) Applications

UV Lamp Monitoring / Water Sterilizer / Air Cleaner/ UV Hardener / UV Irradiator

2. Product Specification and Configuration

1) Display Panel

- Panel Size: $97 \times 50 \times 112 \text{ mm}^3$, Panel cutting size : $92 \times 45 \text{ mm}^2$ (Tolerance : $-0, +0.5 \text{ mm}$)
- Power Supply: $85 \sim 265 \text{ VAC}$ (50/60 Hz), Consumption : $\leq 5 \text{ W}$
- Operating Temperature: $0 \sim 50 \text{ }^\circ\text{C}$, Operating Humidity: $35 \sim 85 \text{ \% RH}$
- Relay : $250\text{AC } 3\text{A}$, Current Output : $4\text{-}20 \text{ mA } 300 \Omega \text{ Max.}$



(1) Display Panel

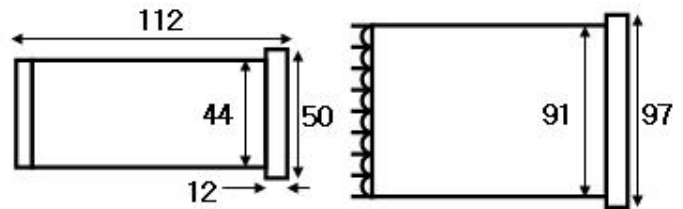

(2) Size of Display Panel

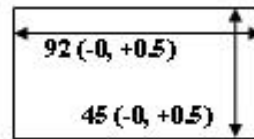

Panel Cut Out (mm)

(3) Panel Cutting Size

Fig. 1 UV Radiometer 5.0

2) Sensor Probe

Green Line : #18, Red Line : #19, Black Line : #20

Information of Sensor Probe is in the enclosed Certificate of Quality (CQ)

3) Power cable and output cable ($4\text{-}20 \text{ mA}$ current output, $1\text{-}5\text{V}$ voltage output, relay) are not supplied.

3. Production Installation

1) Mounting the Sensor Probe

- a. Operation temperature of Sensor Probe is $-30 \sim 85 \text{ }^{\circ}\text{C}$ ($-22 \sim 185^{\circ}\text{F}$)
- b. UV sensor of Sensor Probe and UV light source should be fixed in set distance to do vertically.

Distance is your choice. But optical power should not exceed the 100.00 mW/cm^2 because it is the maximum of Display.

Once a mounting distance has been determined, make sure to use the same distance for any additional sensors used for other lamps; doing so will provide a more accurate comparison of irradiance among different lamps.

- c. In LW series, Sensor Probe connects after close teflon tape 3~4 times in screw page.
- d. After mounting and positioning the sensor probe, make sure the window of Sensor Probe is clean and dry.
If it is not clean, then gently wipe it off with a lint free swab.

2) Mounting the Display Panel

- a. Mount the Display Panel in a temperature & humidity of less than $50 \text{ }^{\circ}\text{C}$ (122°F) & $35 \sim 85 \text{ \%RH}$.
- b. 3 wires of Sensor Probe connect to #18, #19, and #20 of Display.
[18 : Vin (Green), 19 : +5V (Red), 20 : GND (Black)].
- c. Power cable connect to #1 and #2 of Display. (Power is AC voltage. Be careful!)
- d. Voltage Output is 1~5 V DC along relative power, and it is the # 7 (-) and # 8(+) of Display.
- e. Current Output is 4-20 mA DC (300Ω max load) along relative power, and it is the # 9(-) and # 10(+) of Display.
- f. Relay can use the 5A / 230VAC, and its criterion is the setting value of C-01.
5 is N/O (Normal Open), # 4 is N/C (Normal Close), and # 6 is Comm (Common).

If you want to get the short signal under 70 %, you should set 70 in C-01 and connect the each wires in #5 and #6 of Display.

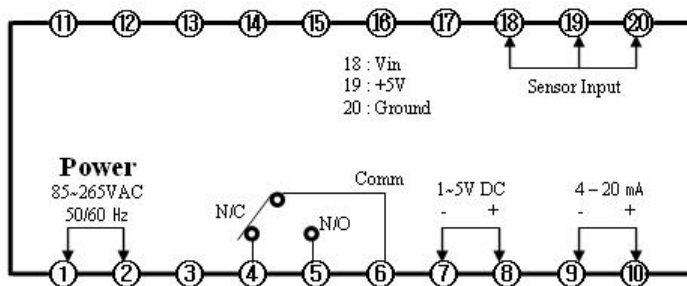

Fig. 2 Connection Diagram of UV Radiometer 5

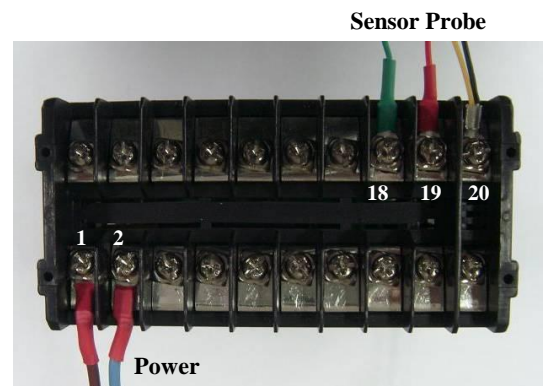

Fig. 3 Connection picture of UV Radiometer 5

4. Operation

1) Setting method of RP (Relative Power)

- a. Establish product with upside.
- b. Turn on the UV lamp and wait 10 minute for stabilization of UV lamp.

Display Window sequence : RP[%] / AT (Accumulative time) [Hours] / AP (Absolute power) [mW/cm^2] / RP

- c. Push Mode button (▼) + Shift button (◀). Window will change to the Setting window.

Setting Window sequence : C-00 / C-01 / C-02 / C-03/C-04

Find the C-00 in Display. If you push the Mode button (▼), Display will be changed.

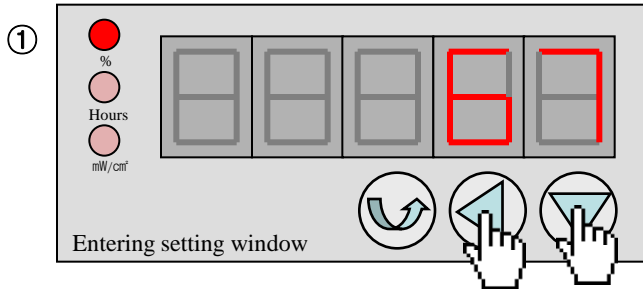

Push Shift + Mode button at same time

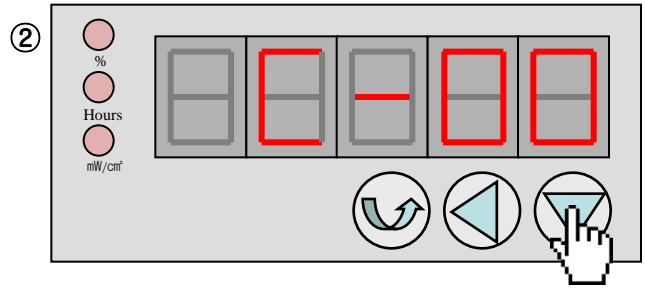

Push mode button will change setting menu

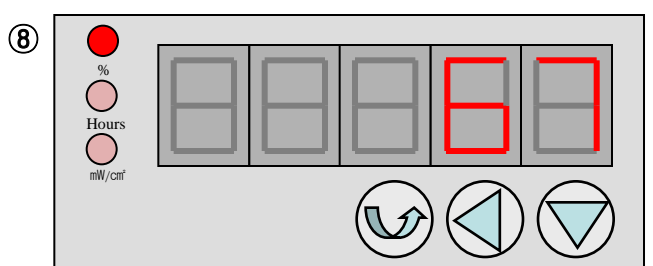
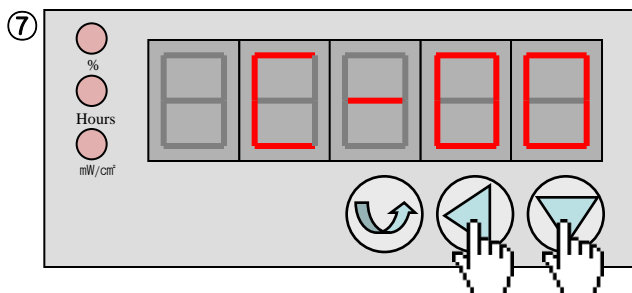
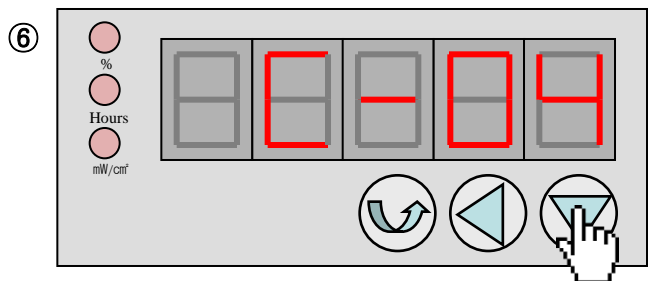
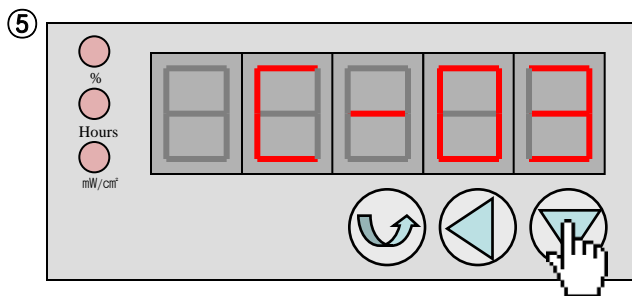
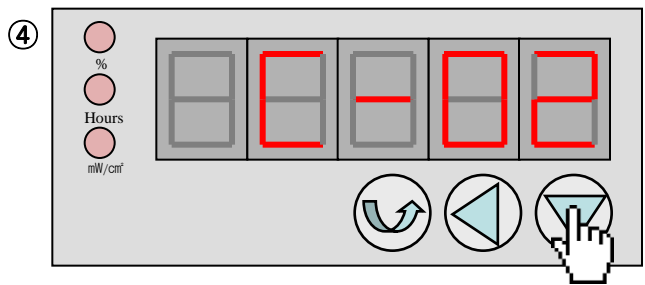
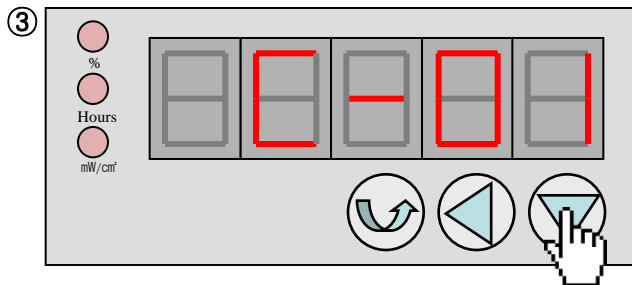

d. Push the Set button (Ⓢ), current RP is displayed instead of C-00.

Push the Set button again, display will be flickering (Set mode).

Push the Set button over 3 second, current optical power will be 100%.

Display Window -> [Mode + Shift button] -> Setting Window -> [Mode + Shift button] -> Display Window

e. If you change the UV lamp, you should do from “b” to “d” for relative power setting.

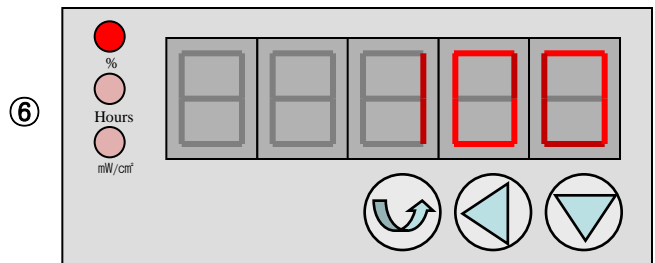
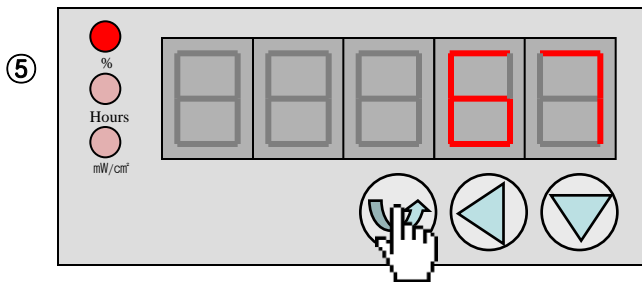
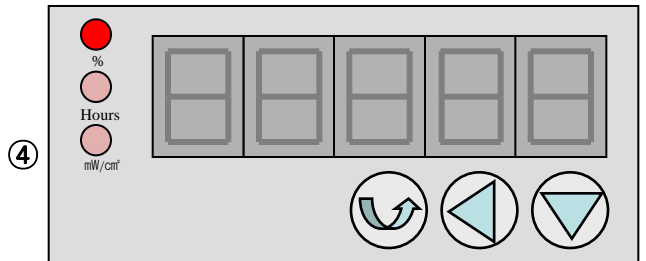
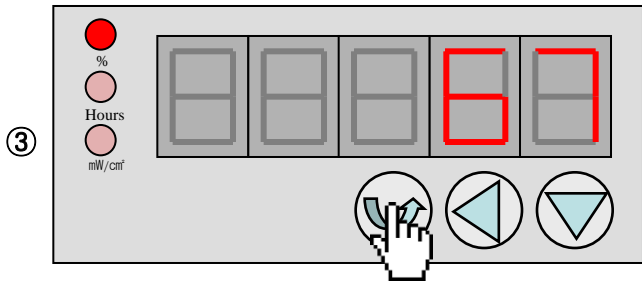
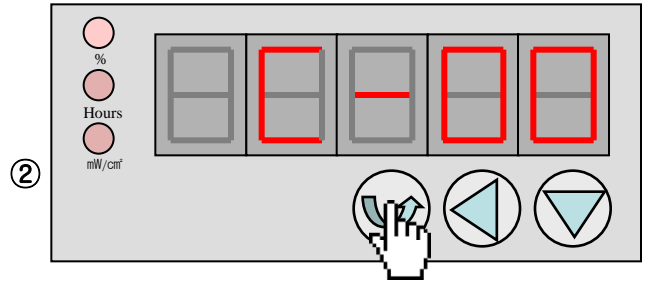
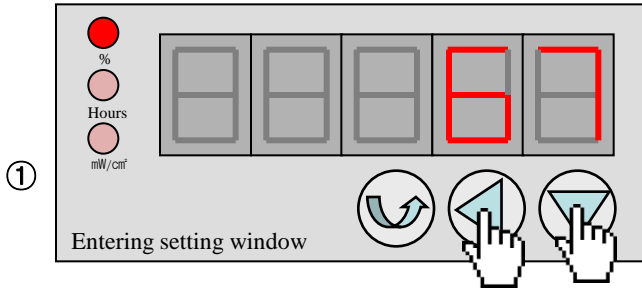

Push Set button over 3 seconds

2) Alarm value of RP

a. Find the C-01 in Setting Window.

b. Push the Set button (⊙), alarm value (Initial value is 50.) is displayed instead of C-01.

Push the Set button again, display will be flickering. This is the setting mode.

Shift button (◀) can change the digit, Mode button (▼) can change the number.

Push the Set button over 3 second. It is end of alarm setting.

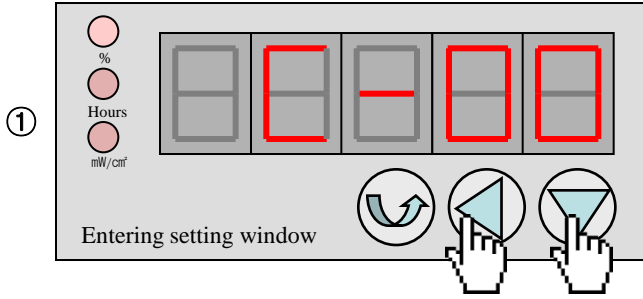

Push Shift + Mode button at same time

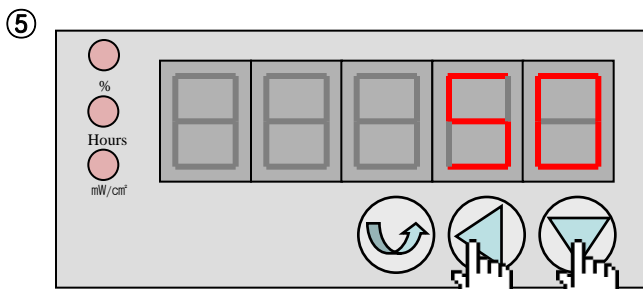
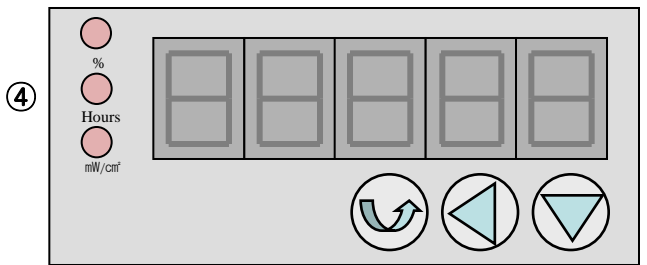
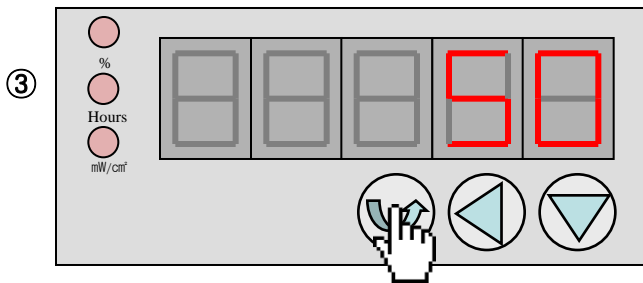
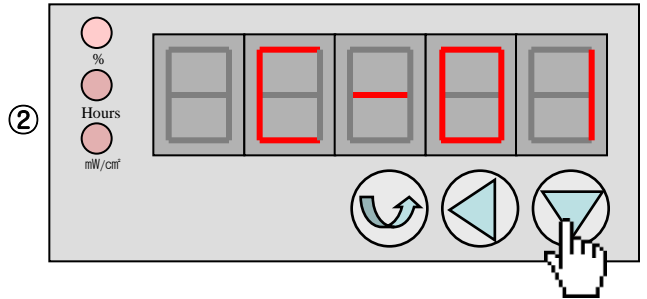

change the digit
change the number

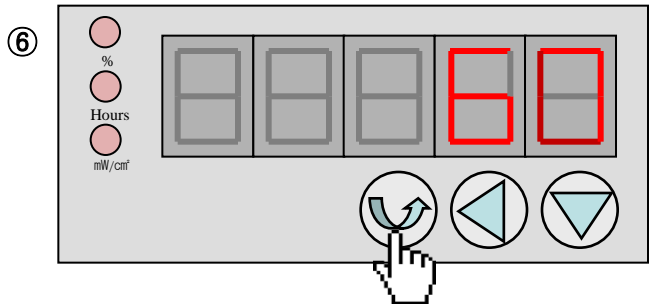

Push Set button over 3 seconds

3) Alarm value of AT

a. Find the C-02 in Setting Window.

b. Set alarm value of AT by method such as b of 2) in view of the life time of UV lamp.

Initial value is 5,000 and maximum value is 19,999.

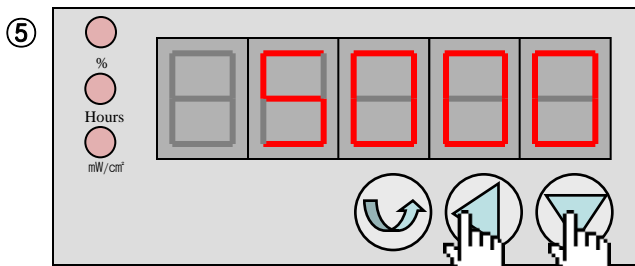
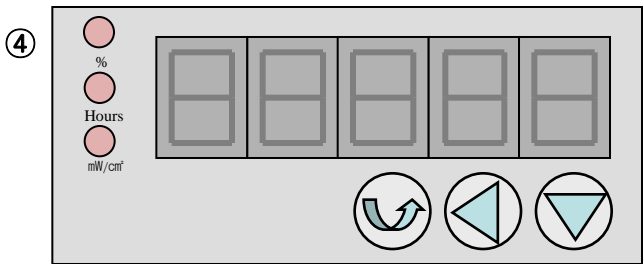
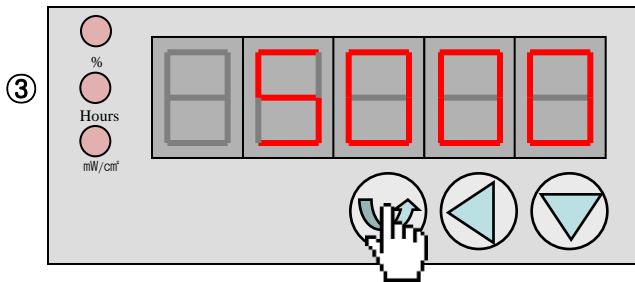
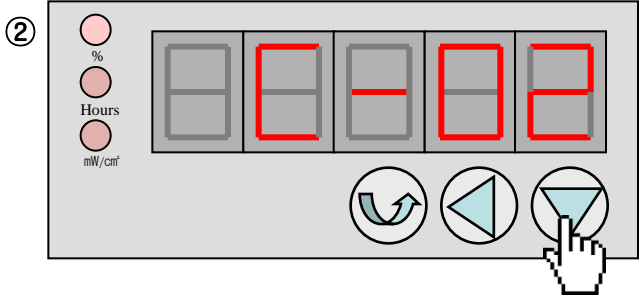
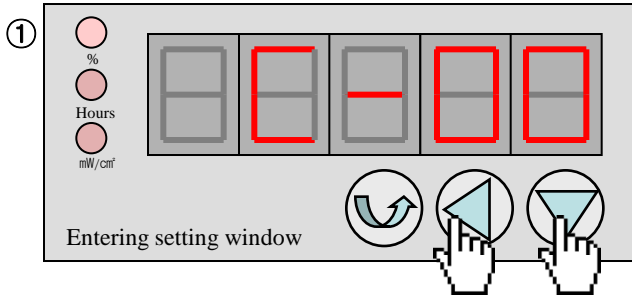

change the digit
change the number

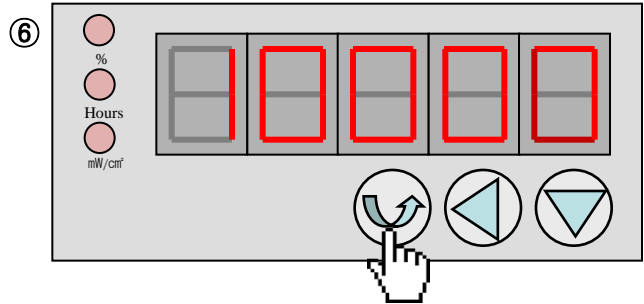

Push Set button over 3 seconds

4) AT reset

Push the Set button over 5 second at displayed AT on display, AT will be zero.

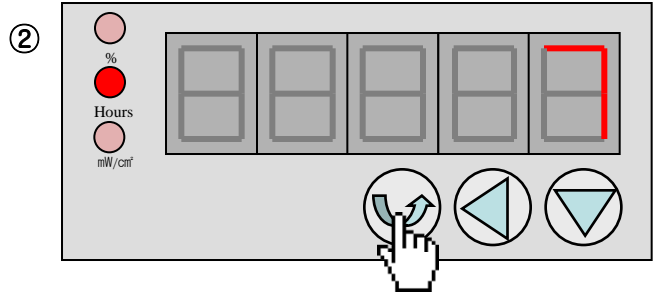
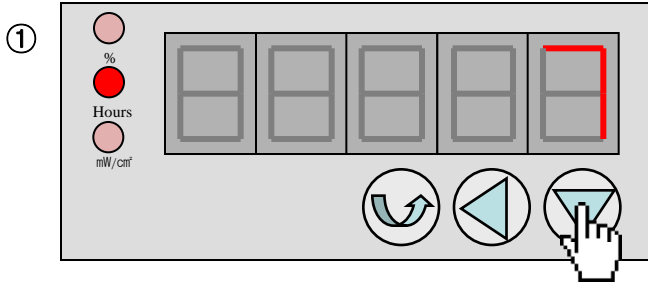

Push Set button over 5 seconds

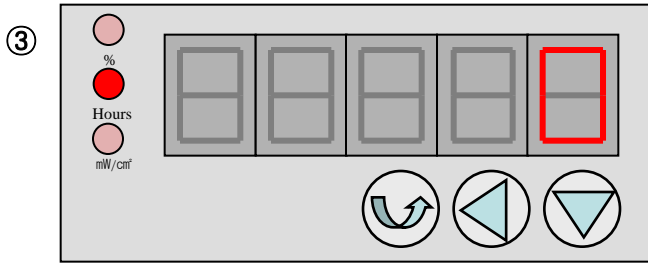

5) Setting of maximum value for displayed intensity.

- a. Find the C-03 in Setting window.
- b. Push the Set button (⊙), value for displayed intensity (initial value is 10,000) is displayed instead of C-03
- c. Push the set button again, display will be flickering. This is the setting mode.
- d. Shift button (◀) can change the maximum value for displayed intensity.
 - Initial value is 10,000 and maximum value is 19,999.
- e. Push the Set button over 3 second, It is end of decimal point settings

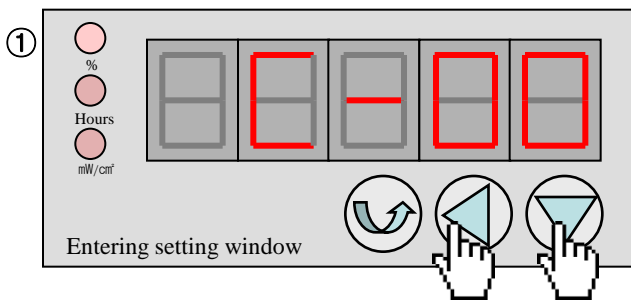

Push Shift + Mode button at same time

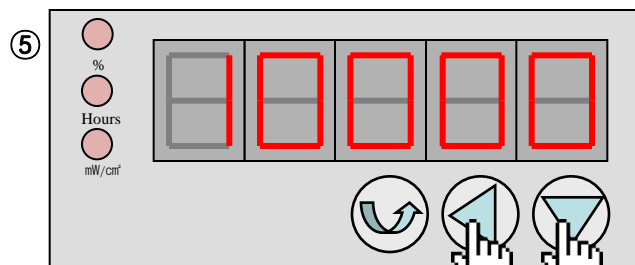
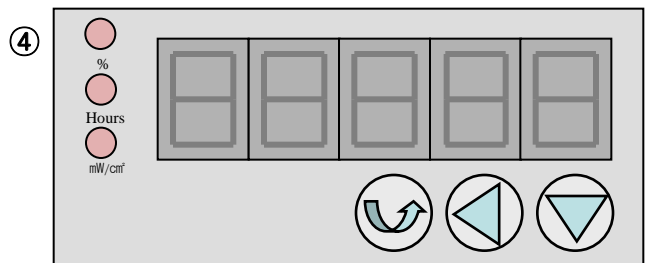
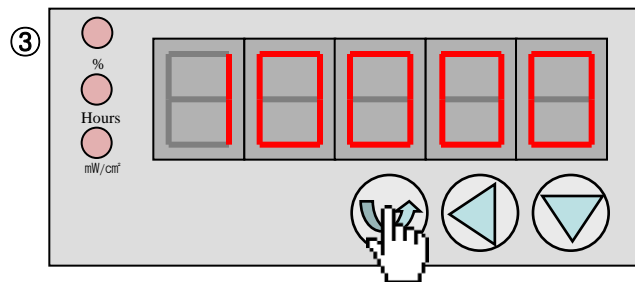
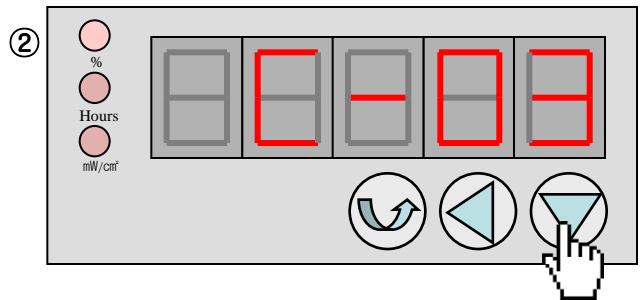

change the digit
change the number

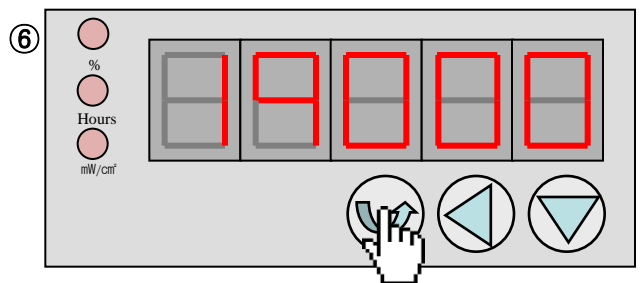

Push Set button over 3 seconds

6) Setting of decimal point position

a. Find the C - 04 in Setting window.

b. Push the Set button (⊙), decimal point (initial value is 000.00) is displayed instead of C-04

c. Push the set button again, display will be flickering. This is the setting mode.

d. Shift button (◀) can change the decimal point, Mode button (▼) can change the decimal point.

e. Push the Set button over 3 second, It is end of decimal point settings.

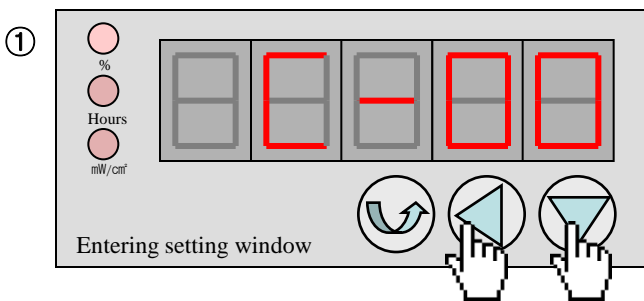

Push Shift + Mode button at same time

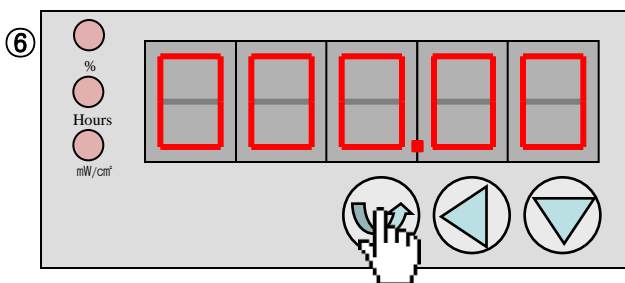
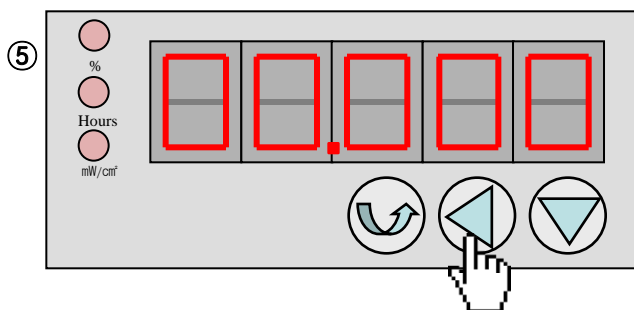
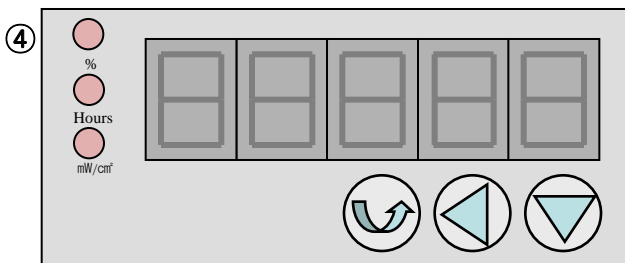
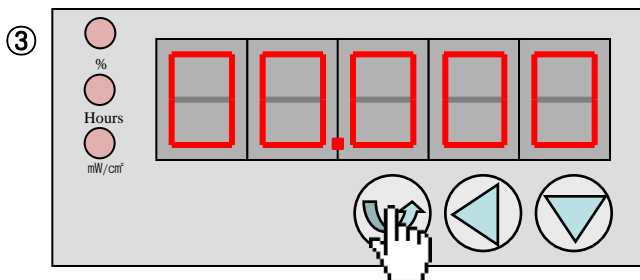
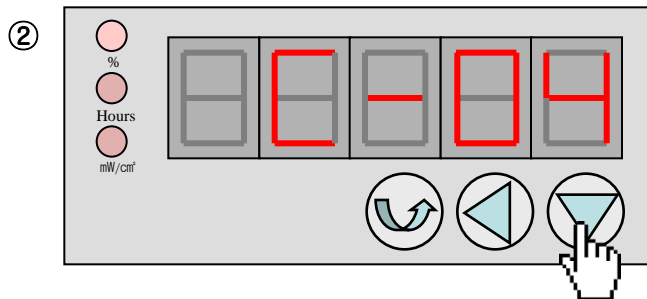

Push Set button over 3 seconds

7) Display Window

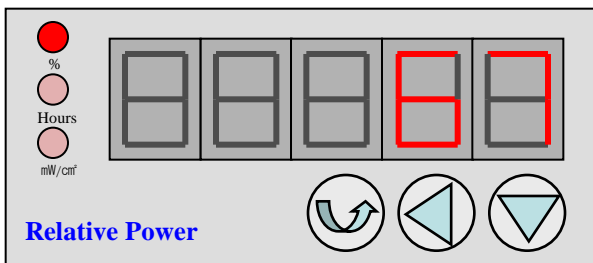
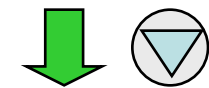
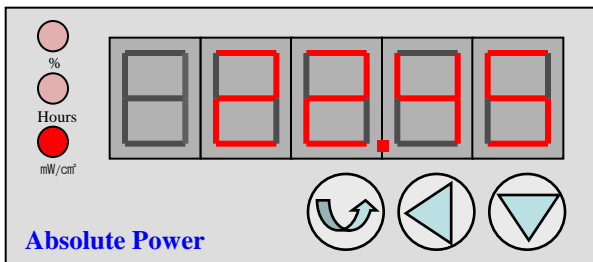
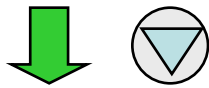
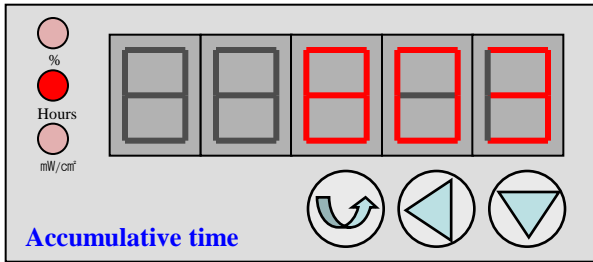
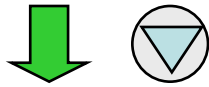
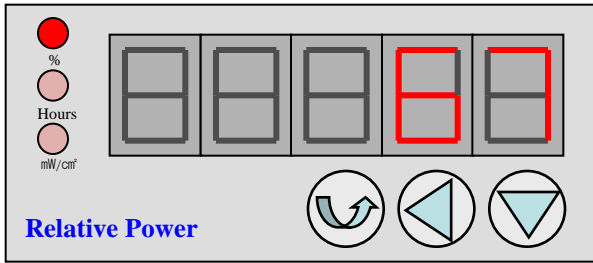

8) Setting Window

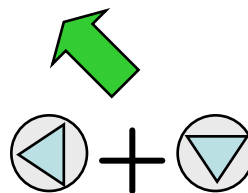
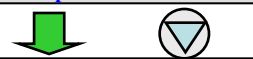
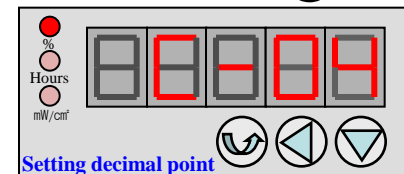
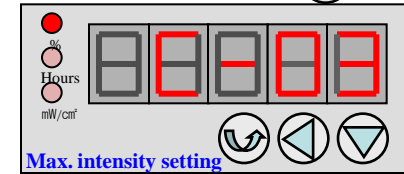
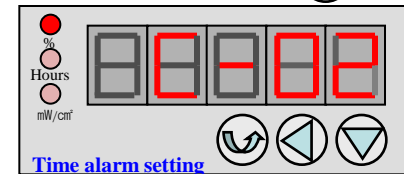
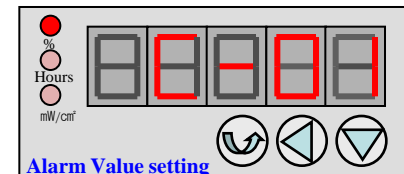
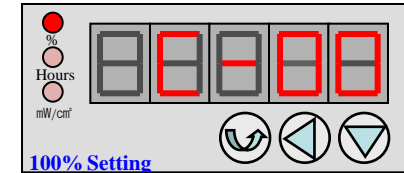
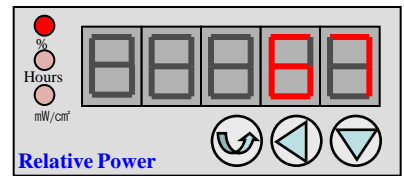

Display Window <-----> Setting Window
[Mode + Shift button]

5. Relative Reaction Curves of UV Sensors

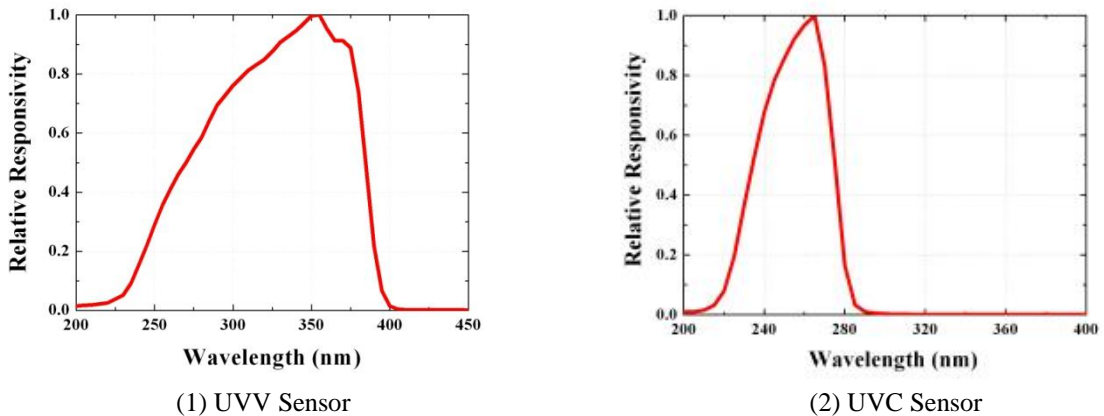

Fig. 4 Relative Responsivity Curve of UV Sensor

6. A/S Request in Case of Product Failure

- 1) Should any failure is found in product, please call the sales company or customer center for A/S.
- 2) Product warranty period is 1 year from the date of procurement with no charge.

However, failure which is caused by user's misuse or carelessness within warrant period or any failure after the warrant period shall be chargeable for it's A/S.

- 3) Product inquiry and on-line customer service

Tel : +82-42-862-3982, Fax : +82-42-862-2982

E-mail : uvsensor@geni-uv.com

Web site : <http://www.geni-uv.com>

7. Notes

1) CAUTION

TURN ALL POWER OFF. NEVER EXPOSE EYES OR SKIN TO UV LIGHT FROM ANY SOURCE
WEAR GLOVES, FACE SHIELD/GLASSES(PER ANSI Z87.1)
AND COVER ALL EXPOSED SKIN. DO NOT TOUCH LAMP GLASS WITHOUT GLOVES.

2) NOTE

Read this entire instruction sheet before starting the installation.

8. Relay Operation method

1) Wiring diagram

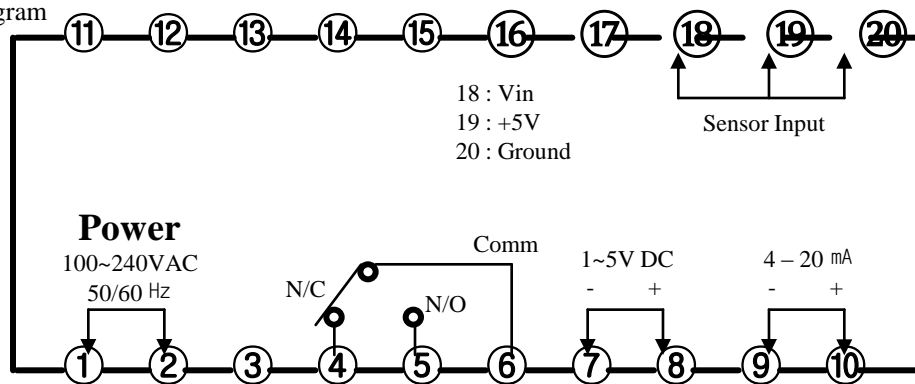

Fig5 Wiring diagram of UV Radiometer 5

- a. Connect AC power Terminal #1 and #2 and connect Sensor cable to terminal #18 (Green wire) #19 (Red wire) #20 (Black wire). Please refer to Fig 6.
- b. Relay output terminal is (#4 ~#5), Voltage output terminal is #7 and #8, current output terminal is #9 and #10. Please turn off the indicator before connect output signal cable. If you want to use relay output please use with #6 and #5 (N/O, Normal open, in normal case the terminal status is open, but if the signal is ON, the terminal will be closed. OR #6 and #4 (N/C, Normal Close, in normal case the terminal status is close, but if the signal is ON, the terminal will be Open). In normal status the relay will contact #6 and #4 and In abnormal status the relay will close #6 and #5. If you use large capacity ballast, please use capacitor (220pF/2kV) as Fig7.
- c. Voltage output(1~5Vdc) terminal is #8(+) and #7(-) and Current output(4-20mA) terminal is #10(+) and #9(-).

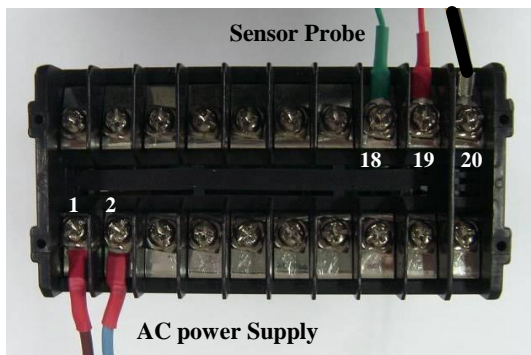

Fig 6. Connect diagram of MG-05

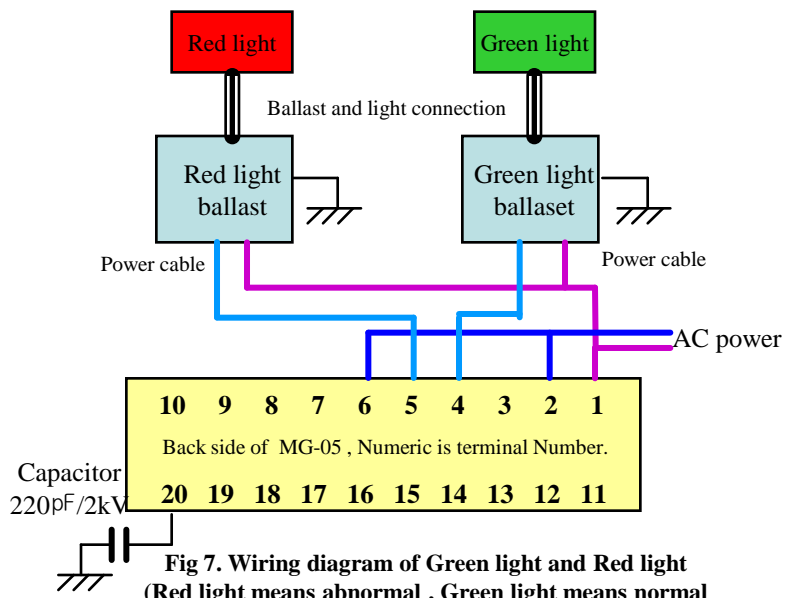

Fig 7. Wiring diagram of Green light and Red light (Red light means abnormal, Green light means normal)

In normal status, the relay will connect #6 and #4, the Green light will be ON and Red light will be off. In abnormal status, the relay will connect #6 and #5, the Green light will be off and Red light will be ON.