

Instruction Manual

MG-02

(UV Radiometer)



1. Product features and applications
2. Product specification and configuration
3. Product installation
4. Product function
5. Relative reaction curve of UV Sensor
6. A/S request in case of product failure
7. Notes

1. Product features and application

1) Features

Absolute power can be verified by connecting the most suitable sensor probe for ultraviolet ray of UVA, UVB and UVC, and relative power can be verified by changing the setting as well. Also contact signal can be obtained when value is higher or lower than set value by using 2 relays.

2) Applications

UV lamp monitoring / water sterilizer / air cleaner/ UV hardener / UV irradiator

2. Product specification and configuration

1) Display panel

- Size: $95 \times 48 \text{ mm}^2$, Power supply: AC 100 ~ 240 V 50/60 Hz (#1, #2 of backside panel), #5 is System Ground
- Panel Cutting Size : $92 \times 45 \text{ mm}^2$ (-0 mm , + 0.6 mm)
- Power consumption : under 5VA, Operating Temperature: 0~50 °C , Operating Humidity: under 85%RH
- Version : First character is output of sensor probe (V : Voltage, I : Current),
Second is option(0 : Relay, I : Relay+4-20 mA , C : Relay+4-20 mA +RS485).

e.g.) II : Output of sensor probe is current & Output of display is Relay+4-20 mA .

2) Connection of Sensor probe

- Red : # 11, Black : #12, Green #7 (Vout) or #6(Iout), White or Yellow : #5
- See the Fig. 1 (2) or Fig. 2
- Current output type is using for long distance (over 10m) .



(1) UV Radiometer 2



(2) Connection method
(Top: Voltage, Bottom: Current)

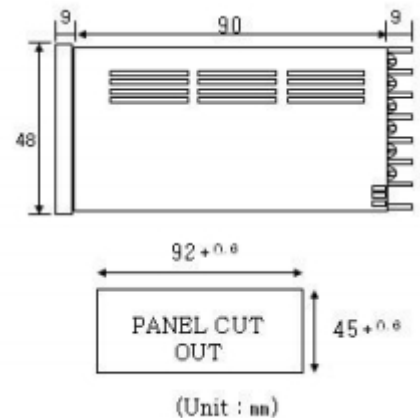

(3) Drawing of UV Radiometer 2.0

Fig. 1 UV Radiometer 2

3) Sensor Probe : See the enclosed Certificate of Quality (CQ)

4) Power Cable, 4-20 mA Current Output Cable, RS485 Communication Cable is not supplied.

3. Product installation

1) Connect wires according to wiring diagram shown in Fig. 2.

- Connect AC power to # 1 and #2, 4 wires [Vcc (Red), GND (Black), Vout or Iout (Green), GND (White or Yellow)] of sensor probe to #11(Vcc), #12(GND), #7(Vout) or #6(Iout) and #5(GND).
- **Connect the ground line of AC power (System Ground) either to #5.**
- When value is higher than set value #13 and #14 the relay (Normal) is short, #15 and #16 the relay (Alarm) is open and the front normal LED is ON, and when the value is lower than set value, the relay (Normal) is open, the Relay (Alarm) is short and front alarm LED is ON.
- 4~20 mA current output and RS485 communication port are optional (In optional condition connect as shown in Fig. 3-1.). In RS485 communication, front Comm LED is ON (No LED when no option is applied).

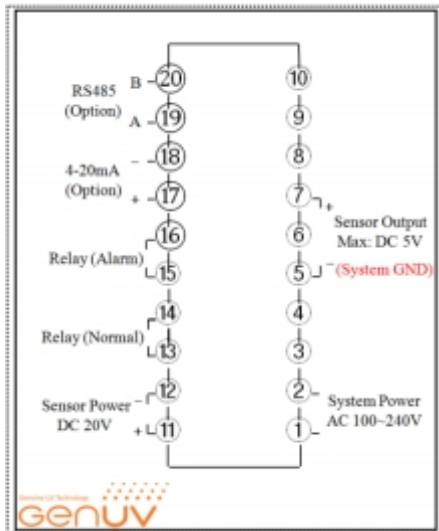

(1) Version : V0, VI, VC

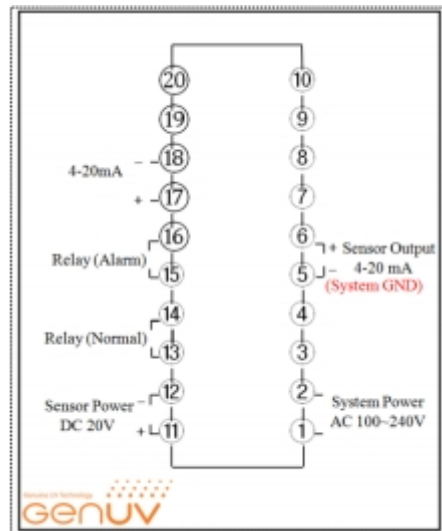

(2) Version : II

Fig. 2 Connection Method of Display

4. Product function

- To set functions, use 3 keys (**Set** ,  , ) in front panel.

1) Setting alarm value and verifying Max/Min value

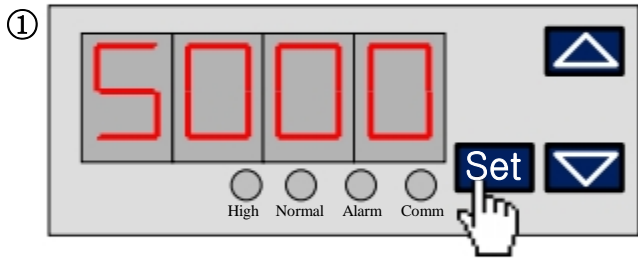

Press **Set** button short

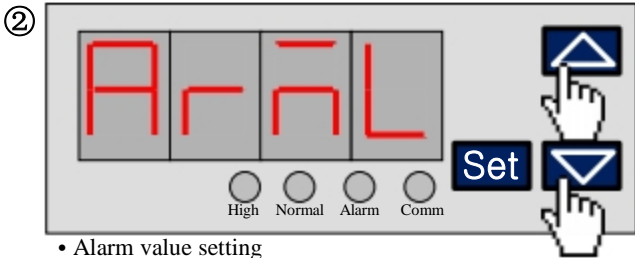

• Alarm value setting

Setting by using  or  Key

Default : See CQ

Click the **Set** button

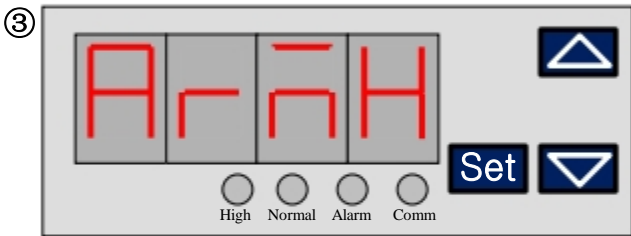

• Not used

Click  the **Set** button

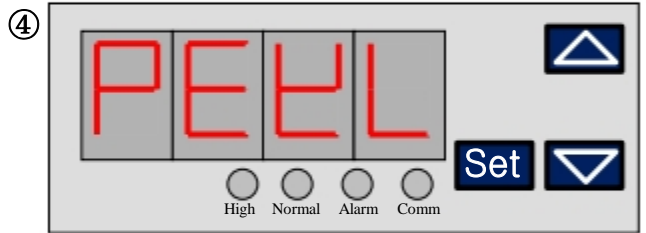

• Min. value indication

Pressing **Set** Key for more than 3 seconds while pressing  Key of the Min. value indication initializes the setting.

Click  the **Set** button

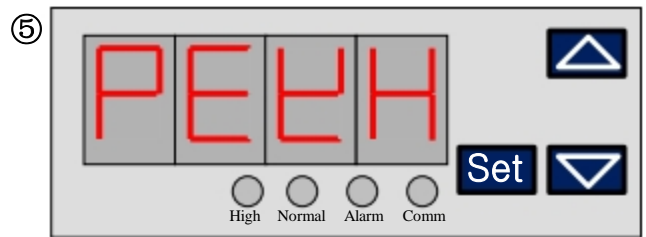

• Max. value indication

Pressing **Set** Key for more than 3 seconds while pressing  Key of the Max. value indication initializes the setting.

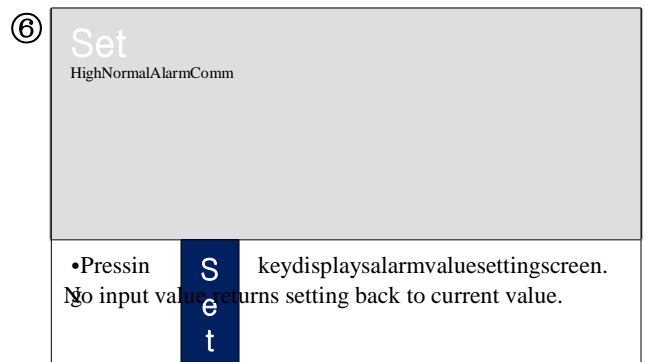

Click the **Set** button



• Pressin **S** key displays alarm values settings screen. No input value returns setting back to current value.

Fig. 3 Alarm Setting

2) Factory setting information and its correction

- Function can be confirmed by Set Key, and can be changed by **Set**, ,  key.
- Factory setting default values are as below and can be adjusted as required. However, only red letter can be changed.

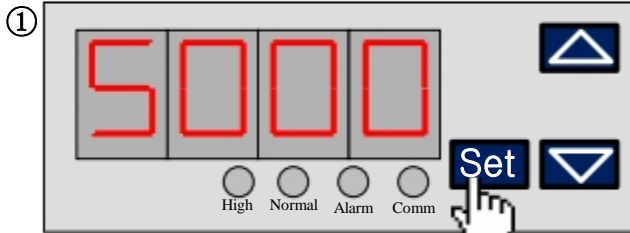

Click the **Set** button for more than 3 seconds

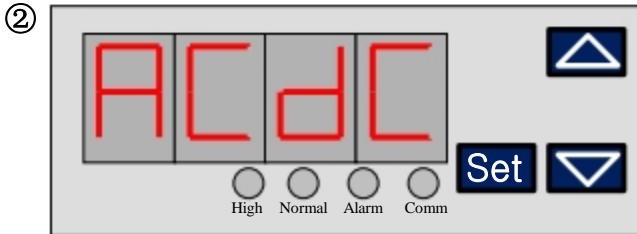

• Selecting input voltage type : Fixed in dc

Click the **Set** button

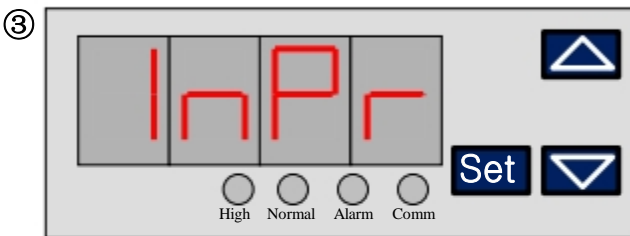

• Selecting of input voltage range: Fixed at 5V or 50 mA

Click the **Set** button

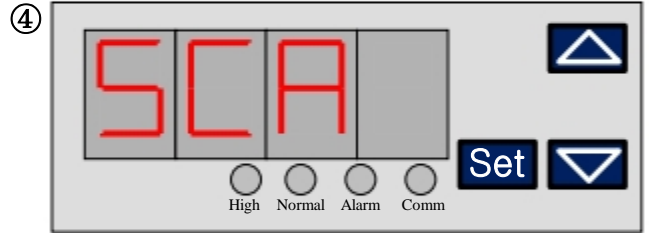

• Selecting of scale use : Fixed at On

Click the **Set** button

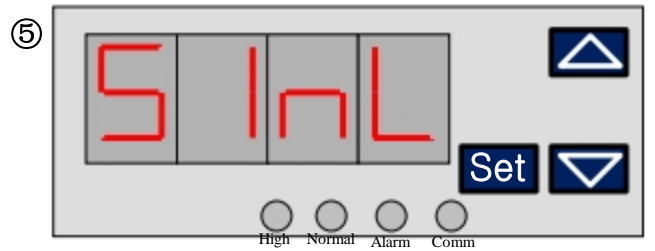

**** Setting of sensor offset voltage

Default : See CQ

If the light source is not present, when the light intensity is less than 0 : Down Offset

If the light source is not present, when the light intensity is more than 0 : Up Offset

Click the **Set** button

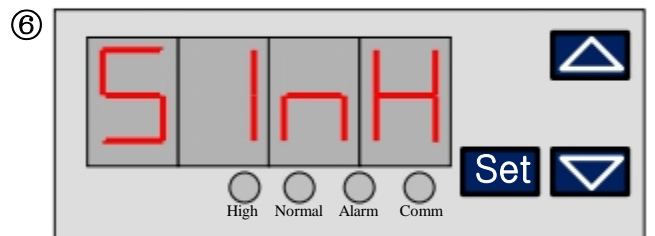

• Setting of sensor Max. voltage : Fixed at 5.000 V or 20.00 mA

Click the **Set** button

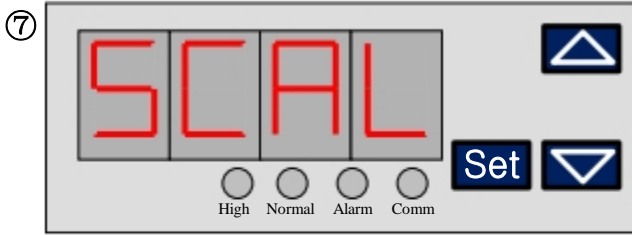

- Setting of min. value for displayed intensity : Fixed at 0

Click the **Set** button

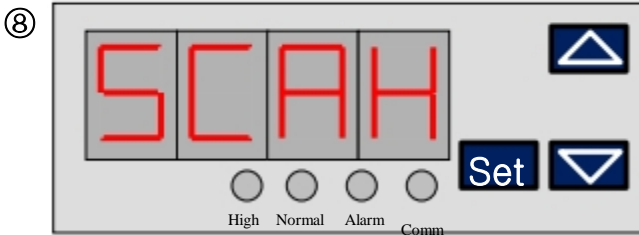

- Setting of sensor Max. voltage
Default : See CQ (Setting range is -998~9999)

Click the **Set** button

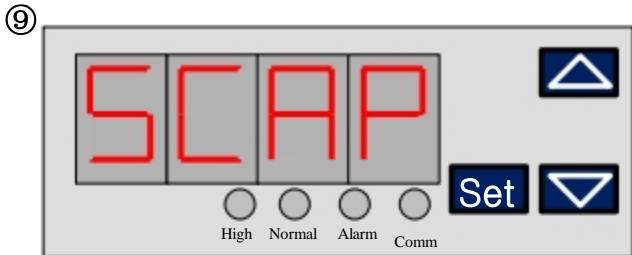

- Setting of decimal point position
: See CQ
(Select among 0000, 000.0, 00.00, 0.000)

Click the **Set** button

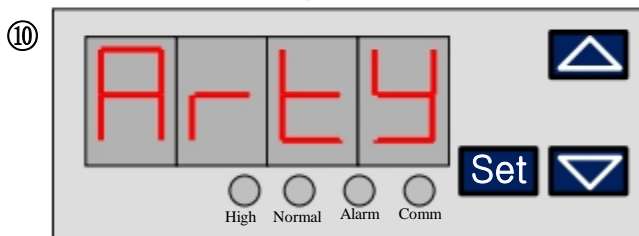

- Setting of relay operation
: Fixed at Art.1
(Choice of off~Art.6)

Click the **Set** button

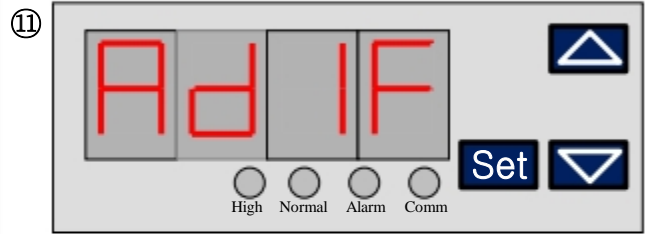

- Setting of relay output deviation : Default 10
Set Alarm Output Variation.
Protect output relay contact point & Prevent mal-fuction by setting certain range between output ON/OFF.
(Choice of 1~5000)

Click the **Set** button

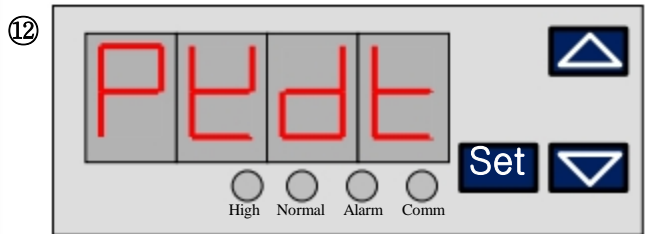

- Delay time for the confirm of Min/Max value: Default 10
Delay time of Peak value monitoring.
delay the monitoring input value to prevent wrong data value input by excessive voltage or current when the initial power input or measurement value input. (Choice of 0~60sec)

Click the **Set** button

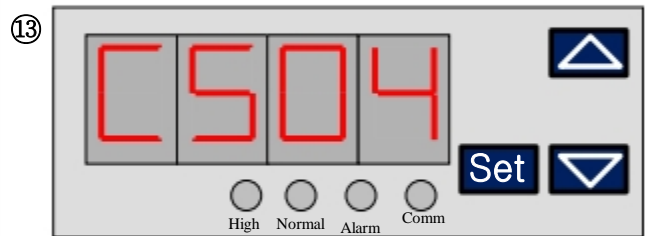

- ** Setting of current output (4mA)

Default : 0

Click the **Set** button

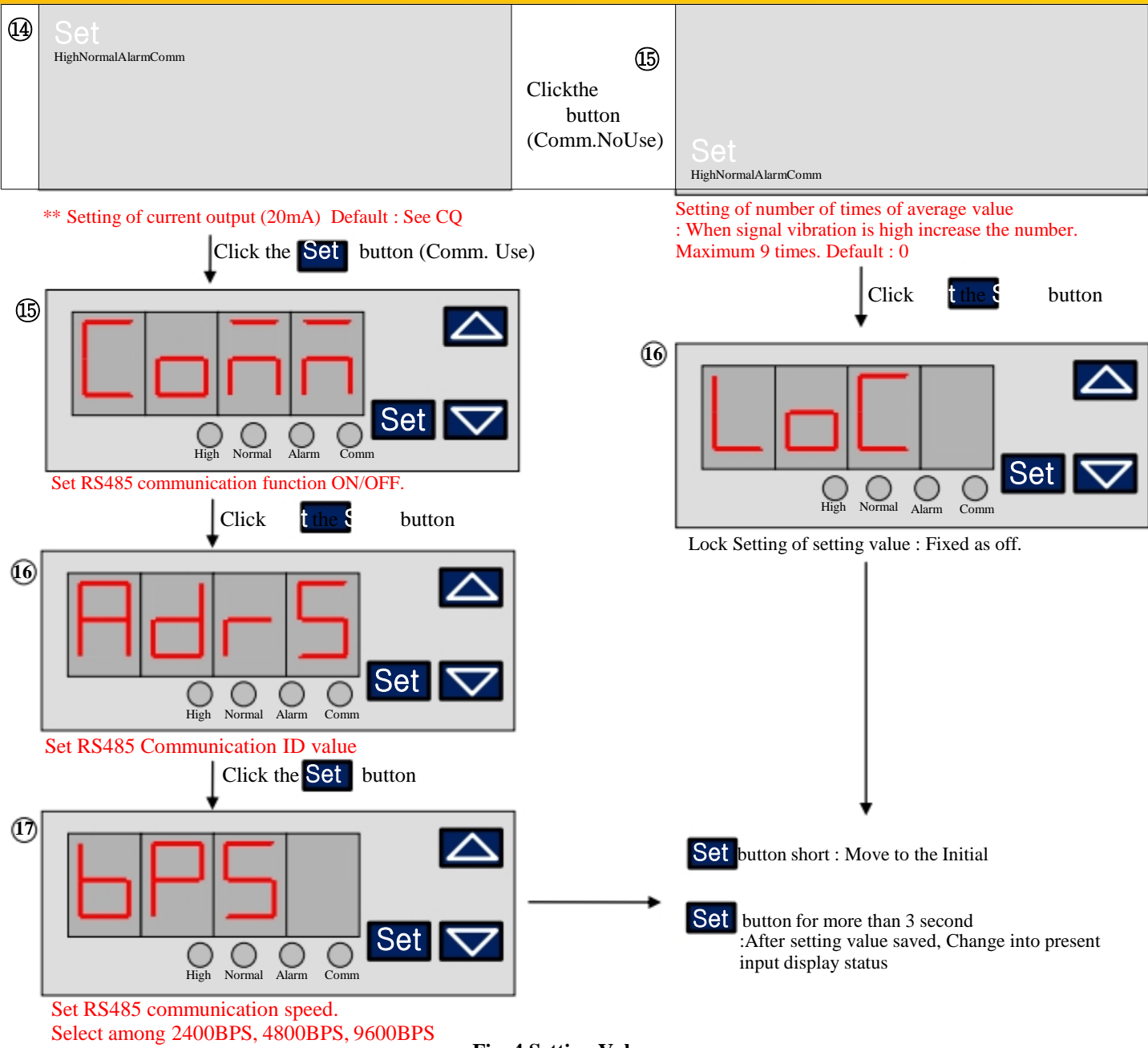

Fig. 4 Setting Value

* Setting Relay output variation
 - This sets the action interval of Relay (Normal) and Relay (Alarm). To operate Relay (Normal) after Relay (Alarm) operation at Alarm value or less, the power shall be Alarm value+ variation of Relay output or more.
 Ex) When Alarm value is 5.0 mW / cm² and variation of Relay output is 1.0 mW / cm², the power shall be 5.0 mW / cm² or less to operate Relay (Alarm), and after operation Relay (Normal) operates when the power is 6.0 mW / cm² or above. If the value is that value or less it is Relay (Alarm) state.
 ** 4 – 20 mA current output is optional. Change is available as required..
 *** RS485 communication is optional. Product with no communication function has no setting function.
 **** The function that sets to indicate power 0 in indication part when power is none.

3) RS485 Communication

a. Basics

- Maximum (32ea), Start Bit (1bit), Data Bit (8 bit), Parity Bit (None), Stop Bit (1 bit)
- Speed (9600BPS, 4800BPS, 2400BPS), Communication ID (0 ~ 255)

b. Table of communication map

2nd Map / 1st Map	00	01	02	03(Read Only)	04	05
0	ACdC	PEdt	AdrS	Current Value	Arty	SCA
1	InPr	PEtL	bPS	X	AdIF	SInL
2	FILt	PEtH	CS04	Normal	ArnL	SInH
3	LoC		CS20	Alarm	ArnH	SCAL
4						SCAH
5						SCAP

c. Set data of communication map

1st+2nd map	Set Menu	Contents	Set data
000	ACdC	Input Voltage Type	0: DC, 1: AC
001	InPr	Input Voltage Range	0: 500V, 1: 50.00V, 2: 5.000V, 3: 500mV
002	FILt	number of times of average value	0 ~ 9
003	LoC	Lock Setting	0:X, 1:Factory Lock, 2: Locked
010	PEdt	Delay time for the confirm of Min/Max value	0 ~ 60
011	PEtL	Min. Value	Reset if 0000
012	PEtH	Max. Value	Reset if 0000
020	AdrS	Communication ID	0 ~ 255
021	bPS	Communication Speed	0: 9600(BPS), 1: 4800(BPS), 2: 2400(BPS)
022	CS04	current output (4mA)	Within displayed value
023	CS20	current output (20mA)	Within displayed value
040	Arty	relay operation	0: X, 1 ~ 6: Operation Type
041	AdIF	relay output deviation	1 ~ 5000
042	ArnL	Alarm Value	Within displayed value
043	ArnH	X	
050	SCA	Selecting of scale use	0: X, 1: 0
051	SInL	Setting of sensor offset voltage	Within displayed value
052	SInH	Setting of sensor max. voltage	Within displayed value
053	SCAL	Setting of min. value for displayed	-999 ~ 9998
054	SCAH	Setting of max. value for displayed	-998 ~ 9999
055	SCAP	Setting of decimal point position	0: 0000, 1: 000.0, 2: 00.00, 3: 0.000

d. Communication Protocol

a) Attention

STX=0x02 (H exadecimal Number)

ETX=0x03 (H exadecimal Number),

'0' (ASCII)=0x30 (H exadecimal Number), '1'=0x31, '2'=0x32, '9'=0x39

'A','B','C',.....'Z'=ASCII

All data is transformed by ASCII except STX,ETX. Decimal point is not transformed.

CHKSUM is remaining value of [sum of (STX++ETX)] / 256.

b) Data Transmission

PC-> Display : STX+'R'+001'(Address)+00'(1 st Map)+0'(2 nd Map)+ETX+00'(CHKSUM)

=> Display ->PC : STX+'A'+001'(Address)+00'(1 st Map)+0'(2 nd Map)+0'(Positive)+0000'(Data)+ETX+00'(CHKSUM)

c) Example of Write

-> STX+'W'+001'(Address)+00'(1 st Map)+0'(2 nd Map)+0'(Positive)+0000'(Data)+ETX+00'(CHKSUM)

-> STX+'W'+001'(Address)+00'(1 st Map)+0'(2 nd Map)+1'(Negative)+0000'(Data)+ETX+00'(CHKSUM)

d) Check the Current Value

STX+'R'+0+0+1+'0'+3+0+ETX +7' (Ten digit of CHKSUM)+'B' (First Digit of CHKSUM)

Explain)

Sum of CHKSUM = STX(0x02)+'R'(0x52)+0(0x30)+0(0x30)+1(0x31)+0(0x30)+3(0x33)+0(0x30)+ETX(0x03)
=0x17B => 7B (Ten digit & First digit)

ASCII value of ten digit is '7'(0x37), & first digit id 'B'(0x42)

If current value is 494 (or 49.4), response will follows;

--> STX+'A'+0+0+1+'0'+0+3+0+0+0+4+9+4+ETX+'6'+B'

5. Spectral responsivity curves of UV sensors

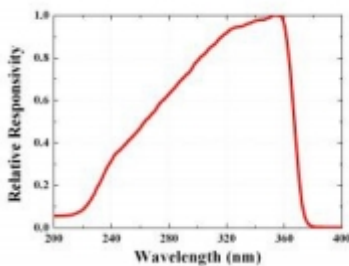

1) UVA Sensor

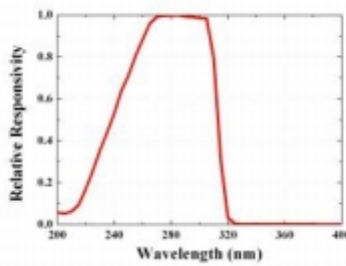

2) UVB Sensor

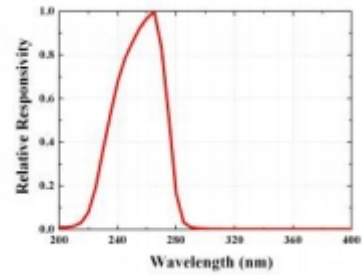

3) UVC Sensor

Fig. 5 Relative Responsivity Curve of UV Sensor

6. A/S request in case of product failure

- 1) Should any failure is found in product, please call the sales company or customer center for A/S.
- 2) Product warranty period is 1 year from the date of procurement with no charge.
However, failure which is caused by user's misuse or carelessness within warrant period or any failure after the warrant period shall be chargeable for it's A/S.
- 3) Product inquiry and on-line customer service : uvsensor@geni-uv.com (<http://www.geni-uv.com>)

7. Notes

1) Warning

The part which has warning indication has not been manufactured as safe equipment, so dual safety equipment shall be installed before using the part in any equipment which may cause serious damage to human body, to property or to important peripherals.

2) Danger

- a. Electrical shock – Do not touch AC terminal while power is on, or serious electrical shock may occur.
- b. Make sure to turn off power before checking power.

3) Caution

- a. In case of AC power connection on to marked part, make sure to use terminal (M3.5, Max width 7.2 mm).
- b. When product is used in other manners other than Genicom has instructed, it may cause injury or property damage.
- c. No dust, water, oil or foreign material of wiring should go into marked part inside, or it may cause fire.
- d. Do not modify or disassemble product.
- e. Check the polarity and application of terminal correctly before connecting.
- f. In order to prevent any inductive noise, please wiring of this product away from high voltage wire, power cable or motor cable.
- g. Use marked part in where is free of followings:
 - ① Dust, corrosion gas or oil or wet place.
 - ② High humidity and high possibility of freezing.
 - ③ Direct sunlight or radiant heat.
 - ④ High vibration or impact
 - ⑤ Place higher than 2,000M.
 - ⑥ Place which environment class is 2 or lower.
- h. In order to turn off power to the marked part, power switch or power breaker shall be installed.
- i. In case of installing marked part to panel, use qualified switch or breaker approved by IEC947-1 or IEC947-3.
- j. Please avoid to use near the equipment which generates strong high frequency noise, such as high frequency wave welder, high frequency machine, large capacity SCR controller.
- k. Plug out power of marked part in case of lightning or the falling of a thunderbolt.
- l. Use of radio may cause malfunction of marked part. Do not use radio.

4) Please read safety instructions carefully before use, and use product correctly .

Sales company shall not be liable to product failure or malfunction which occurs in the state of product damage and abnormal operating. Any disassembling and reassembling of this product without Genicom's approval may cause malfunction and also no service will not be available in such case.